

# Installation Manual

**PAGEONE**  
lighting

ITEM NO.: PP121610

Figure No.1: Unpack the box, and check the contents of the box for the following items below.

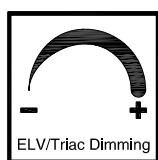

- 3PCS
- 2PCS
- 3PCS
- 3PCS

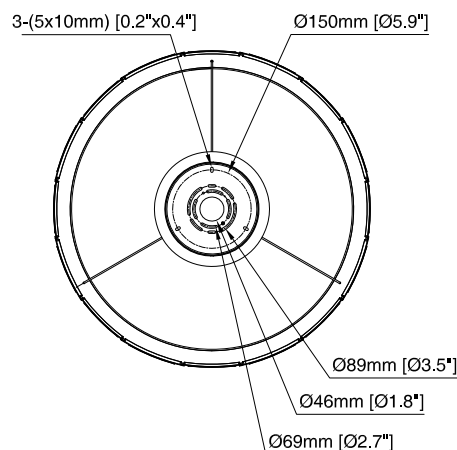
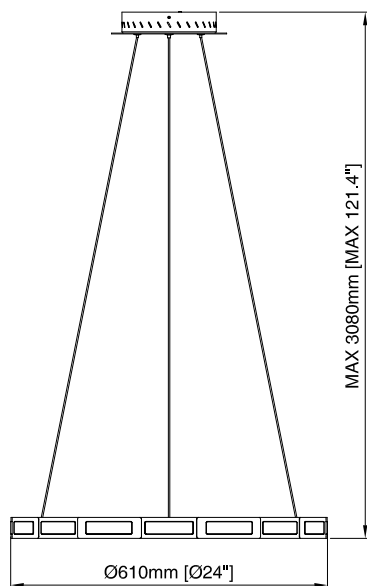
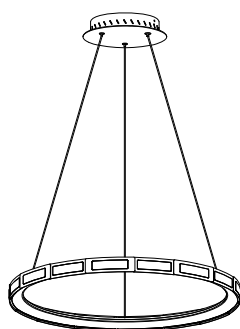

## INSTALLATION INSTRUCTIONS FOR HANGING FIXTURES

### FIGURE 1, 2, 3 AND 4 MOUNTING HARDWARE.

**NOTE: TEST THE CONNECTOR BY GENTLY PULLING IT. IF IT PULLS OUT THE CONNECTION, TRY AGAIN TILL YOU HAVE A FIRM CONNECTION. MAKE SURE NO BARE STRANDS OF WIRE STICK OUT FROM UNDER THE CONNECTORS.**

WHITE OR MARKED WIRE FROM FIXTURE

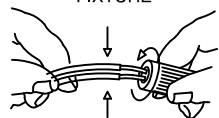

WHITE WIRE FROM OUTLET BOX

FIGURE 1

BLACK OR MARKED WIRE FROM FIXTURE

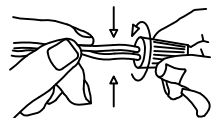

BLACK WIRE FROM OUTLET BOX

FIGURE 2

GREEN OR BARE COPPER WIRE (GROUNDING WIRE)

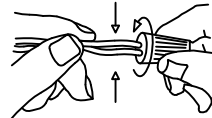

GREEN OR BARE COPPER WIRE (GROUNDING WIRE)

FIGURE 3



FIGURE 4

### CAUTION:

"Warning", "This product is to be installed by a qualified electrician only."  
"Suitable for dry locations only"

### CAUTION:

1. The safety of the appliance is ensured by carefully following the mounting instructions and it is therefore necessary to conserve them.
2. When installing and whenever acting on the appliance, ensure that the power supply has been switched off.

### INSTALLATION: See fig. A, B, and C

1. Carefully read the Electrical Connection section and make electrical connections.
2. Assemble lighting onto the outlet box as shown on back page.

### ELECTRICAL CONNECTIONS: See fig. 1, 2, 3, and 4

1. Connect the white wire from the fixture to the white wire of the electrical outlet box.
2. Connect the black wire from the fixture to the black wire of the electrical outlet box.
3. Connect the grounding conductor from the fixture to the grounding wire of the electrical outlet box.
4. Spread out the electrical wires so that the black ones are on one side of the outlet box and the white ones are on the other side, and carefully introduce them into the outlet box.
5. Fastened and secure the hanging fixture to its mount with the light fixture screws.

# Installation Instructions Sections

**PAGEONE**  
lighting

ITEM NO.: PP121610

A

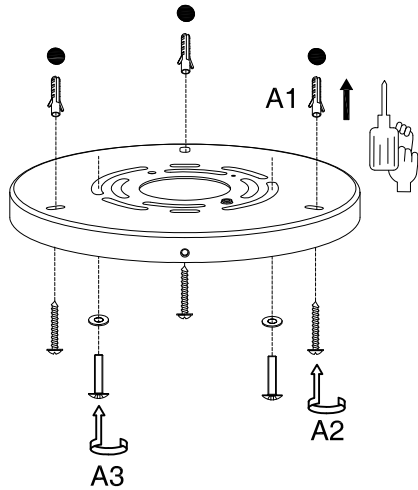

B

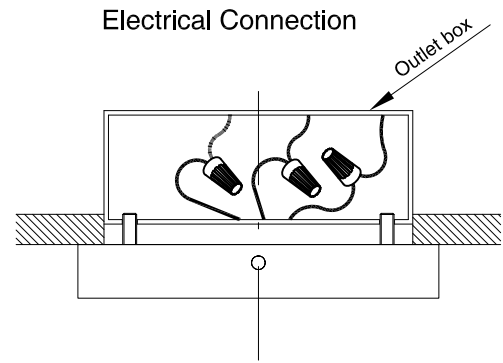

C

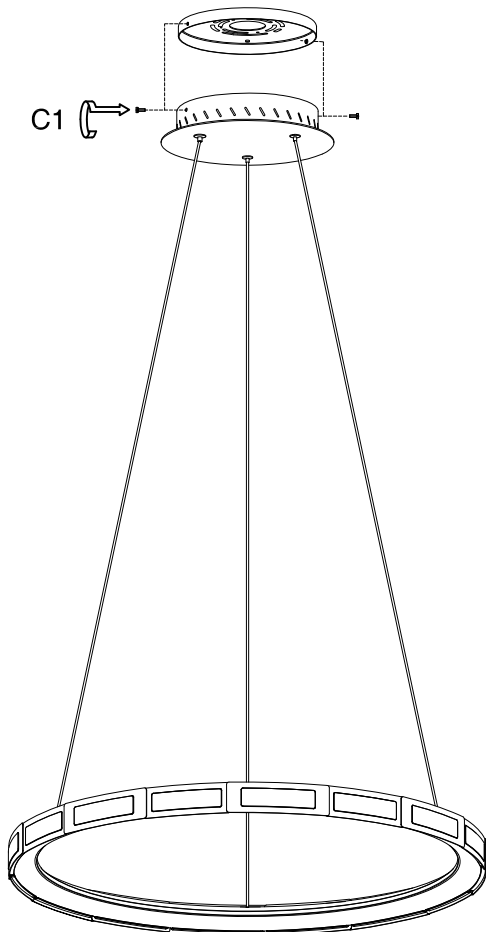

D

